



Countertop Water Filter Clean Water Machine

Replacement Cartridge Instructions

for use with AQ-CWM2-B



1. Twist filter chamber cap to the left and remove old filter from cap. Discard old filter.

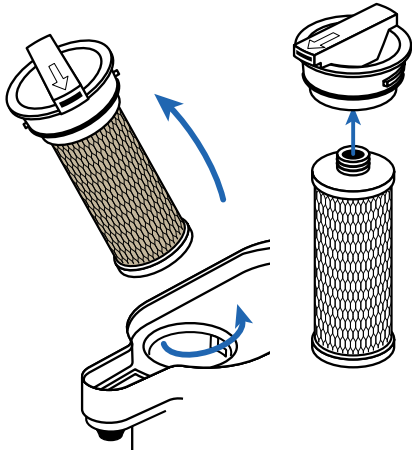

2. Remove plastic from new filter. Press new filter into filter chamber cap ensuring a snug fit. Insert into housing unit and twist right to close.

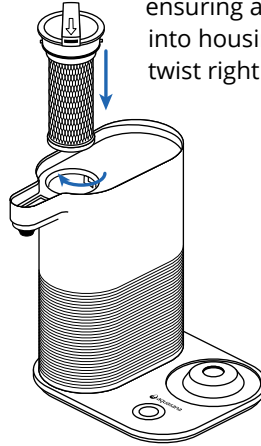

3. Fill water tank and place on dispenser dock.

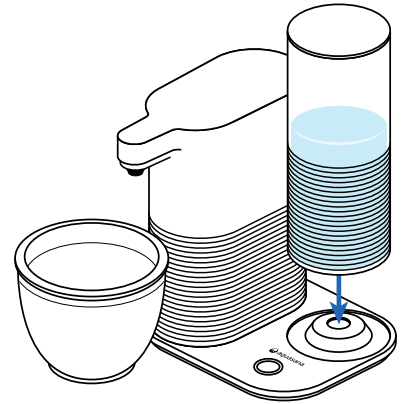

4. Press dock button 3 times quickly. Light will illuminate red for 5 seconds.

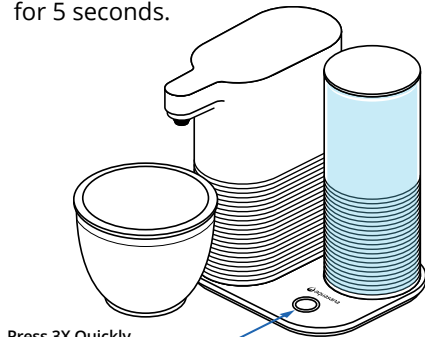

Press 3X Quickly
Solid Red for 5 seconds

5. Press and hold dock button for 1 second to begin flush. Light will blink red during the 60 second clean.

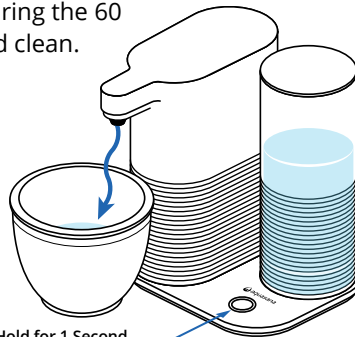

Press & Hold for 1 Second
Blinks Red 60 seconds

6. Once the flush is complete, light blinks blue for 5 seconds, then illuminates solid blue for 5 seconds.

NOTE:
Do not drink flushed water. Discard water.

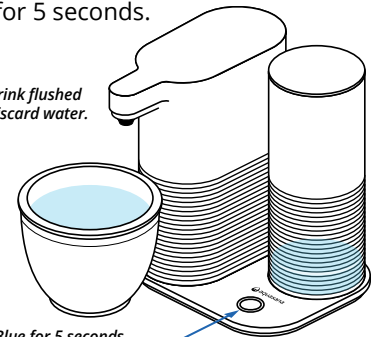

Blinks Blue for 5 seconds -
Solid Blue for 5 seconds



Replace your filters on time, without worry — auto-delivered to you, for less.



Free
Shipping



Discount
Replacements



No
Contract



Extended
Warranty

CONTACT US TO LEARN MORE waterforlife@aquasana.com

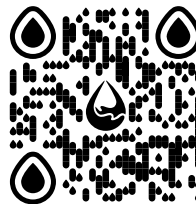

Scan for
Performance Data Sheet



Do not use with water that is microbiologically unsafe or of unknown water quality without adequate disinfection before or after the system.

AQUASANA, INC.

6310 Midway Road
Haltom City, Texas 76117
USA 866.662.6885 • CAN 877.332.7873
aquasana.com

AQ-CWM2-R-2021_0915